

Order Vandercook parts and print manuals from:

NA GRAPHICS  
P.O. 467  
Silverton, CO 81433

Phone: (970)387-0212  
Fax: (970) 387-0127  
[nagraph@frontier.net](mailto:nagraph@frontier.net)

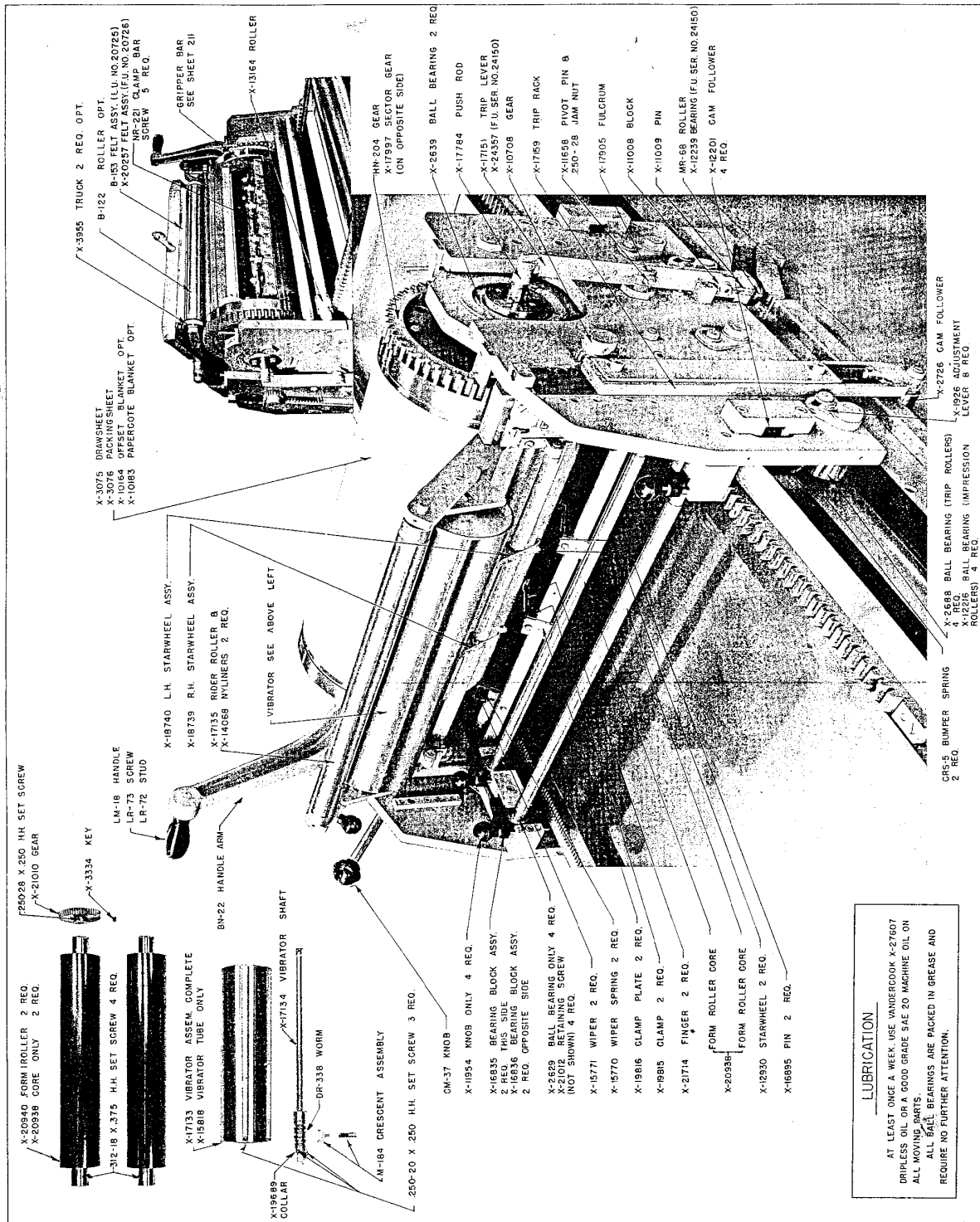

LUBRICATION

AT LEAST ONCE A WEEK, USE VANDERCOOK X-27607  
 DRIPLESS OIL OR A GOOD GRADE SAE 20 MACHINE OIL ON  
 ALL MOVING PARTS.  
 ALL BALL BEARINGS ARE PACKED IN GREASE AND  
 REQUIRE NO FURTHER ATTENTION.

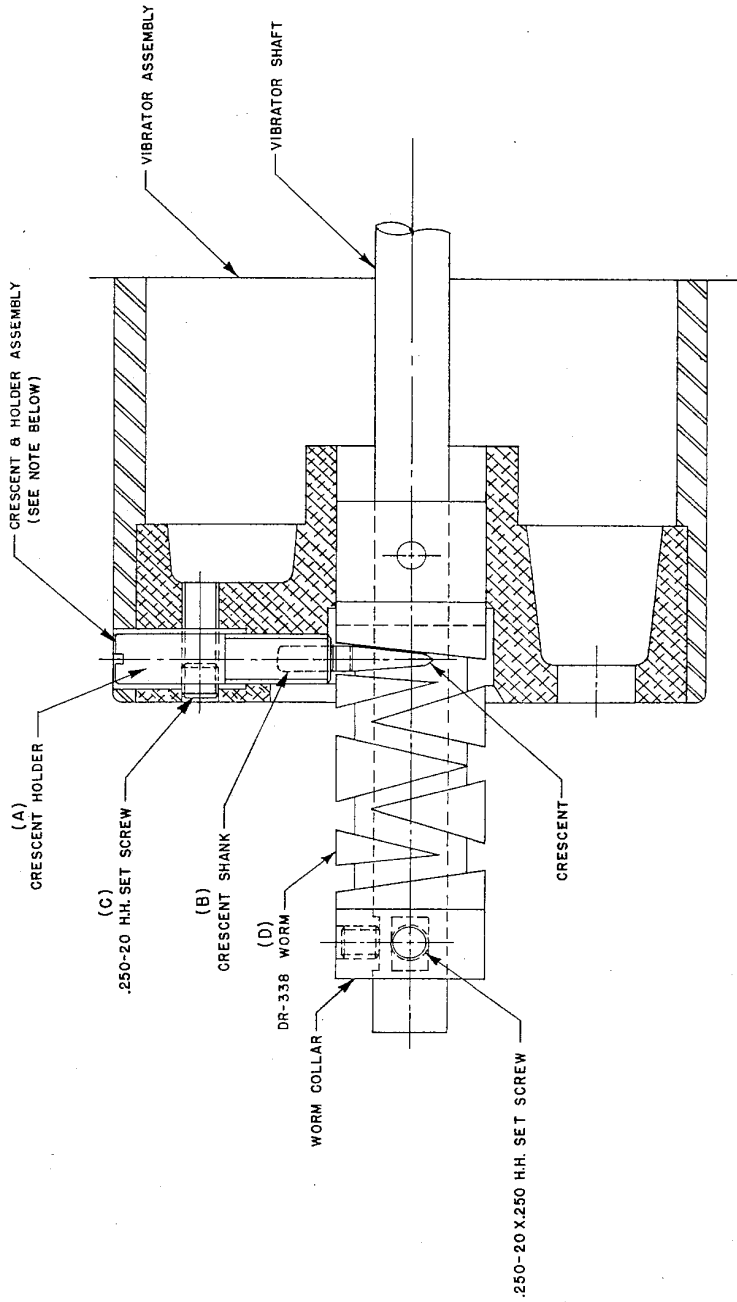

PARTIAL SECTION VIEW OF INK DRUM VIBRATOR ASSEMBLY

- ① ADJUST CRESCENT HOLDER-(A) UNTIL IT TOUCHES END OF CRESCENT SHANK-(B). THEN BACK OFF 3/4 OF A TURN AND LOCK HOLDER WITH .250-20 H.H. SET SCREW-(C). THIS SETTING MUST ALLOW WORM-(D) TO ROTATE FREE OF ANY DRAG, TRAVELING FULL LENGTH BOTH DIRECTIONS.
- ② COAT VIBRATOR WORM WITH GRAPHITE GREASE OR VASELINE.

NOTE— CRESCENT AND HOLDER ASSEMBLY AS SHOWN IS PART NO. M-184. THE ABOVE INSTRUCTIONS APPLY ALSO TO X-2031 CRESCENT AND HOLDER ASSEMBLY (NOT SHOWN).

## CRESCENT OR WORM REPLACEMENT INSTRUCTIONS

VANDERCOOK UNIVERSAL I & III TEST PRESSES

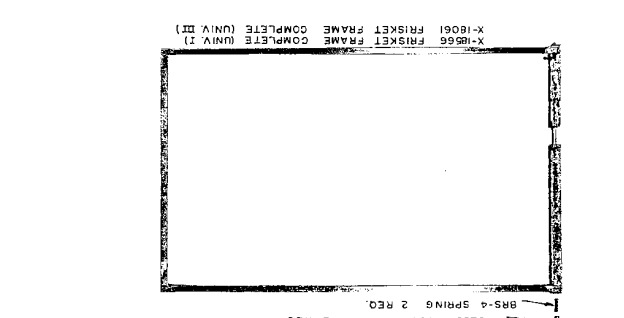
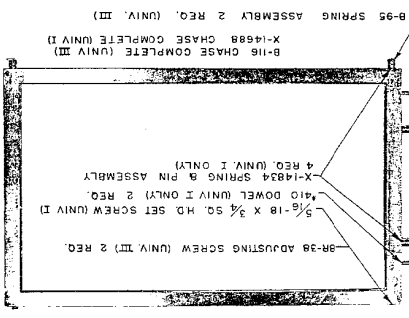
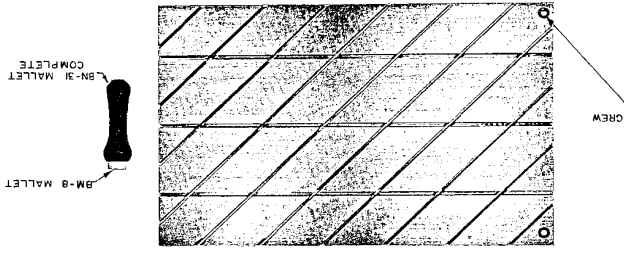
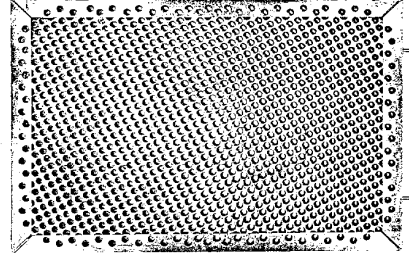
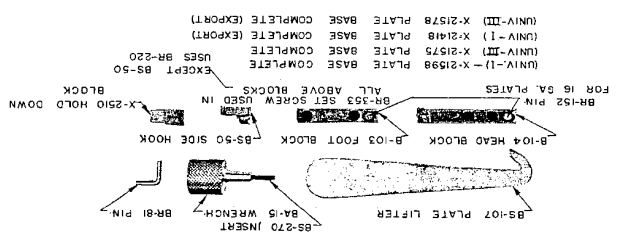
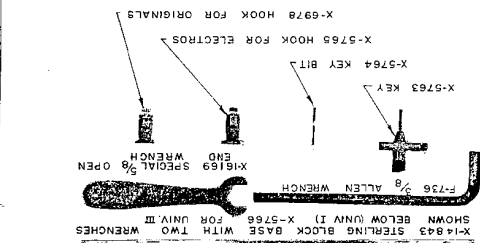
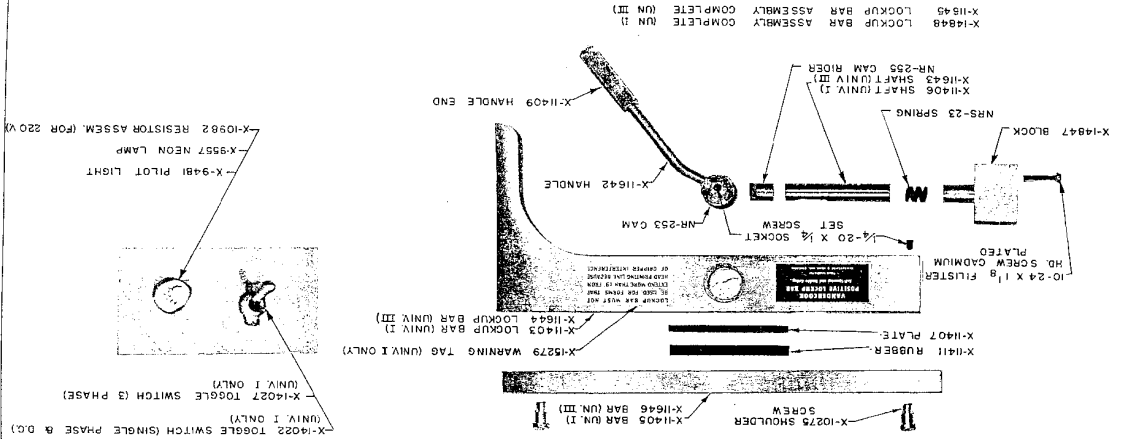

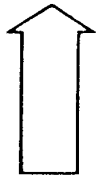
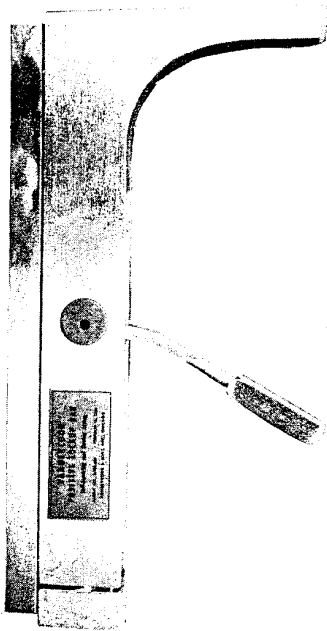

**LOCKUP BAR ASSEMBLY (COMPLETE)**

VANDERCOOK MODEL NO.	PART NO.	WIDTH
3, 4, SPI5, 15-20, 15-21	X-11410	15.000"
UNIVERSAL I	X-14848	15.500"
319	X-17800	18.250"
UNIVERSAL II, III, 219 (ALL)	X-11645	19.000"
SP20	X-20322	20.062"
425	X-17000	24.250"
325	X-11897	25.000"
SP25	X-23071	25.250"

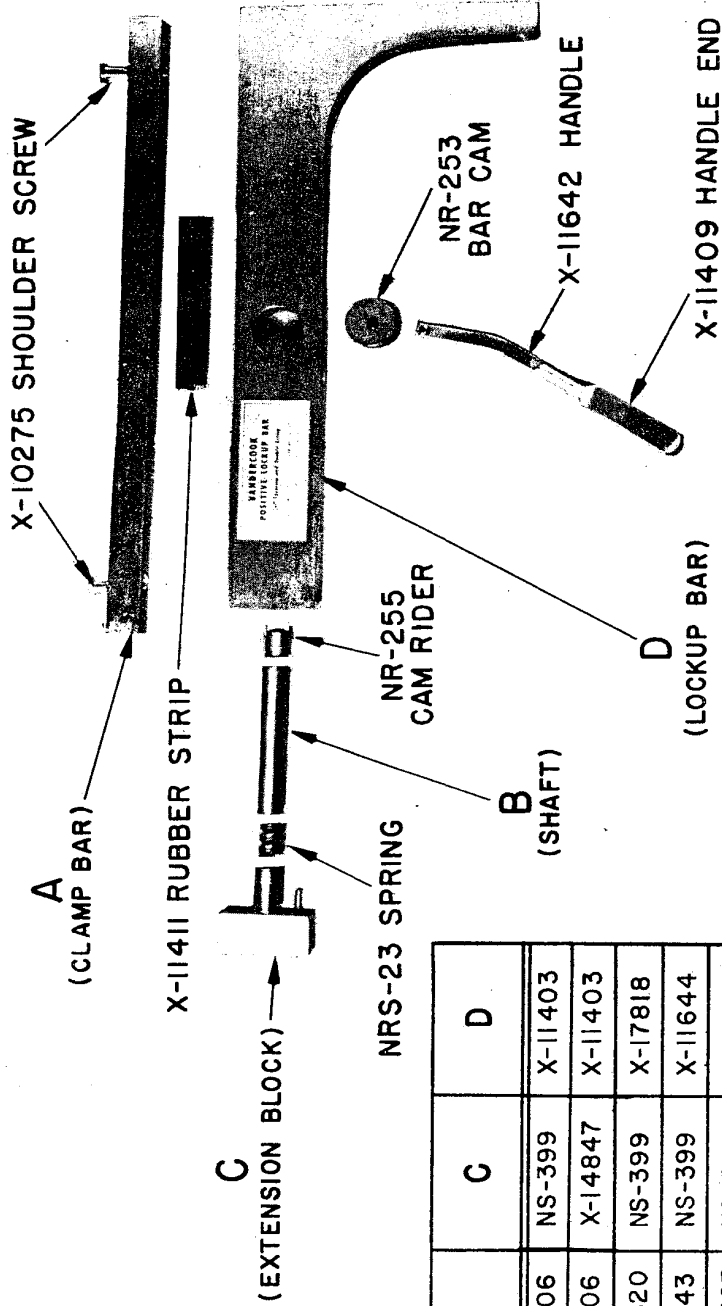

VANDERCOOK MODEL NO.	A	B	C	D
3, 4, SPI5, 15-21	X-11405	X-11406	NS-399	X-11403
UNIVERSAL I	X-11405	X-11406	X-14847	X-11403
319	X-17819	X-17820	NS-399	X-17818
UNIV. II, III, 219	X-11646	X-11643	NS-399	X-11644
SP20	X-11896	X-20323	NS-399	X-11886
425	X-17005	X-17004	NS-3999	X-17003
325	X-11899	X-11898	NS-399	X-11887
SP25	X-11899	X-11898	X-23072	X-11887

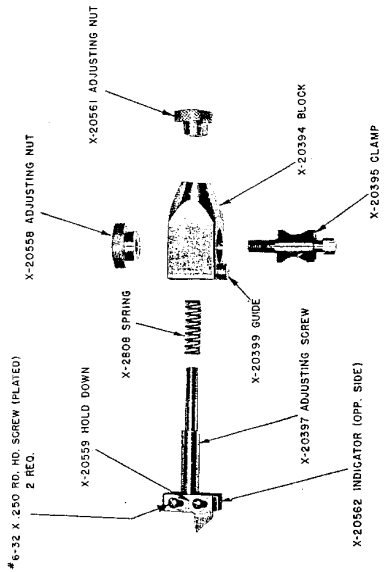

X-20556 SIDE GUIDE ASSEMBLY (COMPLETE)

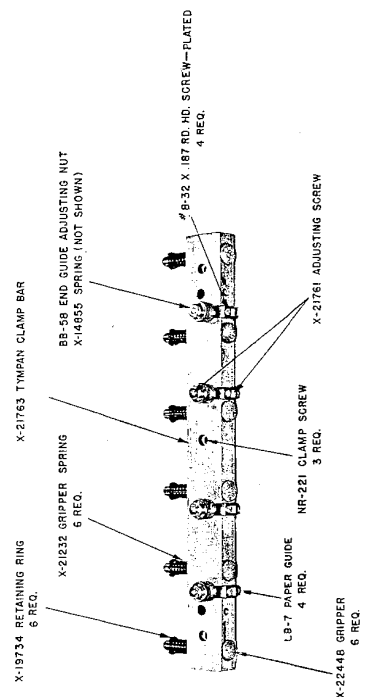

X-21768 GRIPPER BAR ASSEMBLY (COMPLETE)

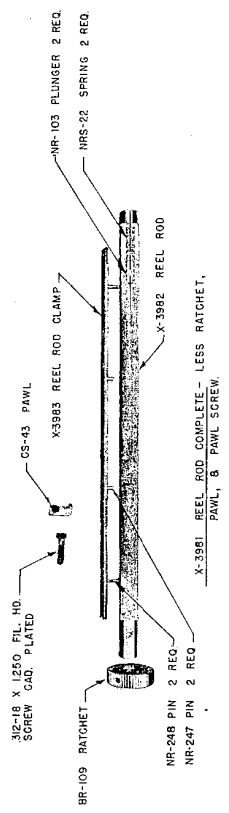

F-778 SCREWDRIVER



B-113 ROLLER SETTING GAUGE



F-144 3/4 OPEN END WRENCH

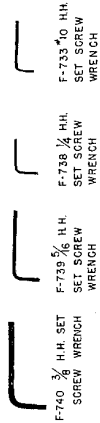

F-740 3/4 H.H. SET SCREW WRENCH  
 F-739 1/2 H.H. SET SCREW WRENCH  
 F-733 1/4 H.H. SET SCREW WRENCH



#10-32 X .250 TRUSS HD. SCREW 6 REC.  
 X-24503 WIPER BLADE  
 X-22439 CLAMP BAR (NOT SHOWN)



F-982 3/2-18 X .750 NYLOC SET SCREW

X-25630 WASHUP TRAY ASSEMBLY (COMPLETE)

X-18021 TOOL SET (COMPLETE)

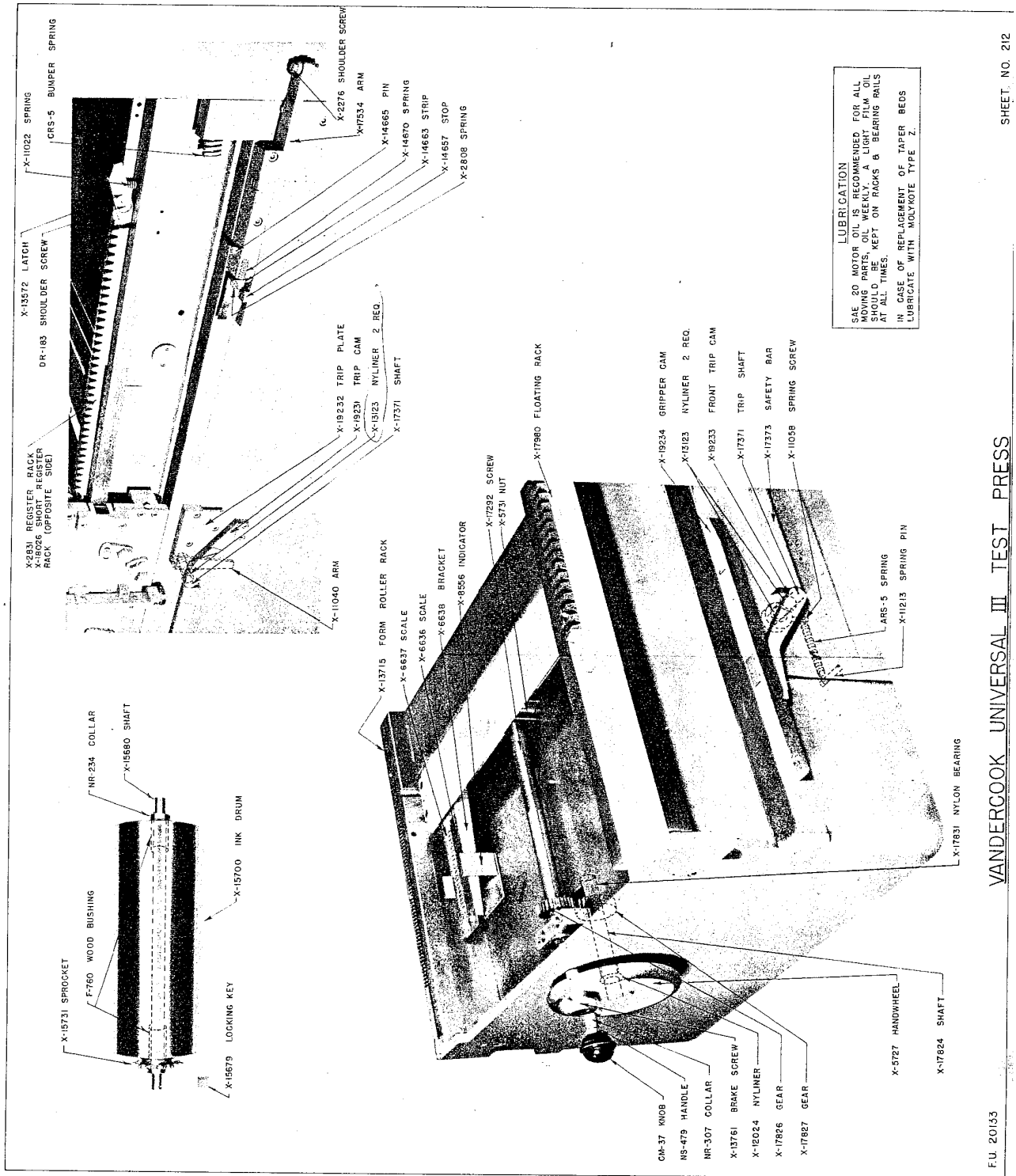

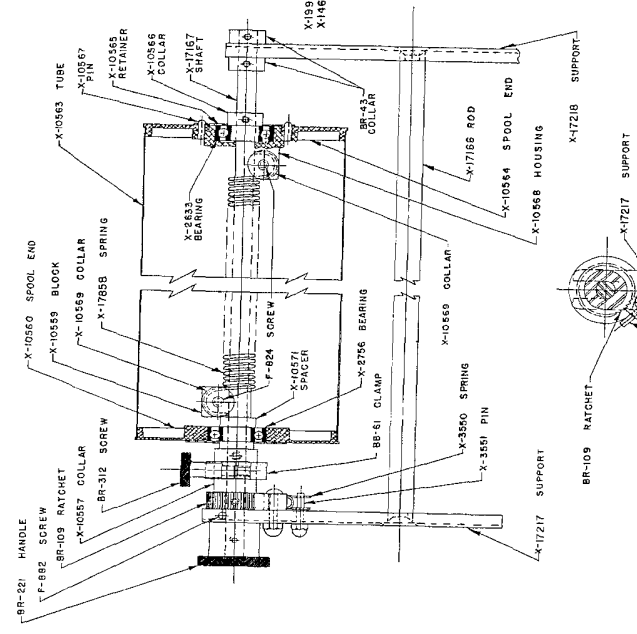
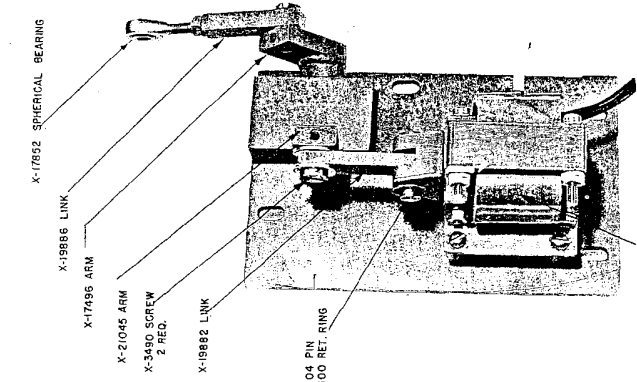

X-19879 SOLENOID (FOR 60 CYCLES)  
 X-19880 SOLENOID (FOR 50 CYCLES)  
 LUBRICATE LINKAGE WEEKLY  
 X-20202-1  
 AUTO-GRIPPER OPENER  
 (E.L. 220B)

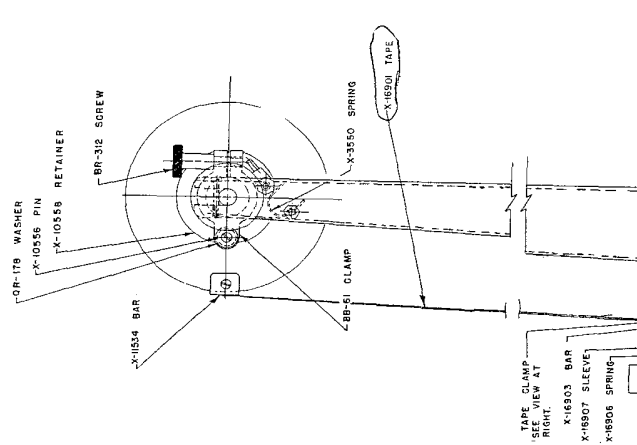

BR-221 HANDLE  
 F-682 SCREW  
 BR-109 RATCHET  
 X-10557 COLLAR  
 BR-312 SCREW  
 X-10563 SPOOL END BLOCK  
 X-10559 COLLAR  
 X-10569 COLLAR  
 X-1785B SPRING  
 X-2833 BEARING  
 X-10567 PIN  
 X-10565 RETAINER  
 X-10565 COLLAR  
 X-17167 SHAFT  
 BR-433 COLLAR  
 X-17162 ROD  
 X-10564 SPOOL END HOUSING  
 X-17218 SUPPORT  
 X-10566 BEARING  
 F-824 SCREW  
 X-10571 SPACER  
 X-2756 BEARING  
 BB-51 CLAMP  
 X-10569 COLLAR  
 X-3550 SPRING  
 X-3551 PIN  
 X-17217 SUPPORT  
 BR-109 RATCHET  
 BR-240 PIN  
 CS-43 PAWL  
 X-3551 PIN  
 X-3550 SPRING  
 X-16522 PLATE  
 X-18523 R.H. CLAMP (UPPER SIDE)  
 X-18524 L.H. CLAMP  
 X-18520 THUMB SCREW  
 STAKE IN PLACE

**LUBRICATION**  
 AT LEAST ONCE A WEEK, USE VANDERCOOK X-27607  
 DRIFLESS OIL OR A GOOD GRADE SAE 20 MACHINE OIL ON  
 ALL MOVING PARTS.  
 ALL BALL BEARINGS ARE PACKED IN GREASE AND  
 REQUIRE NO FURTHER ATTENTION.



CONTROL STATION - PLAIN POWER  
X-17949 COMPLETE ASSEMBLY

CONTROL STATION - WITH AUTOMATIC TAPE DELIVERY  
X-18287 COMPLETE ASSEMBLY

CONTROL STATION - WITH AUTOMATIC GRIPPER OPENER  
X-18288 COMPLETE ASSEMBLY

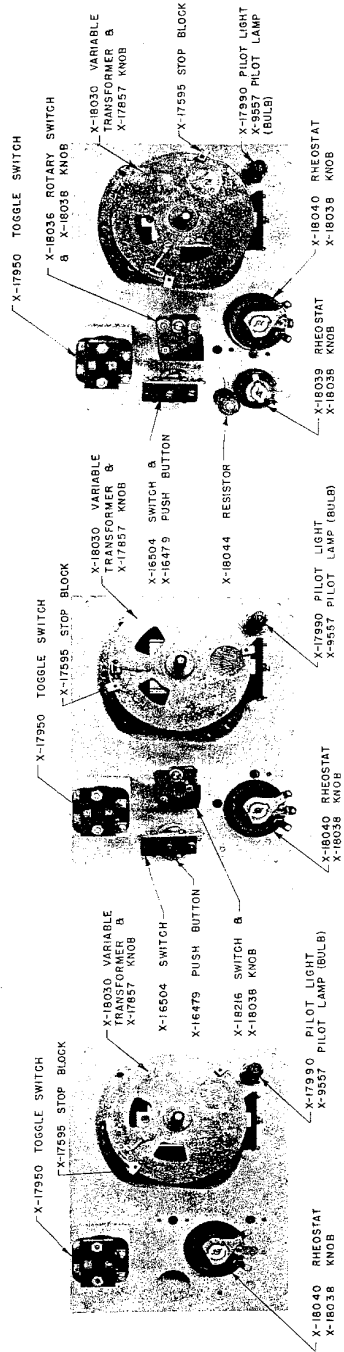

PANEL ASSEMBLY - COMPLETE ASSEMBLY - WITH AUTOMATIC GRIPPER OPENER ONLY  
X-18286 - COMPLETE ASSEMBLY - WITH OTHERS  
X-18285 - COMPLETE ASSEMBLY - ALL OTHERS

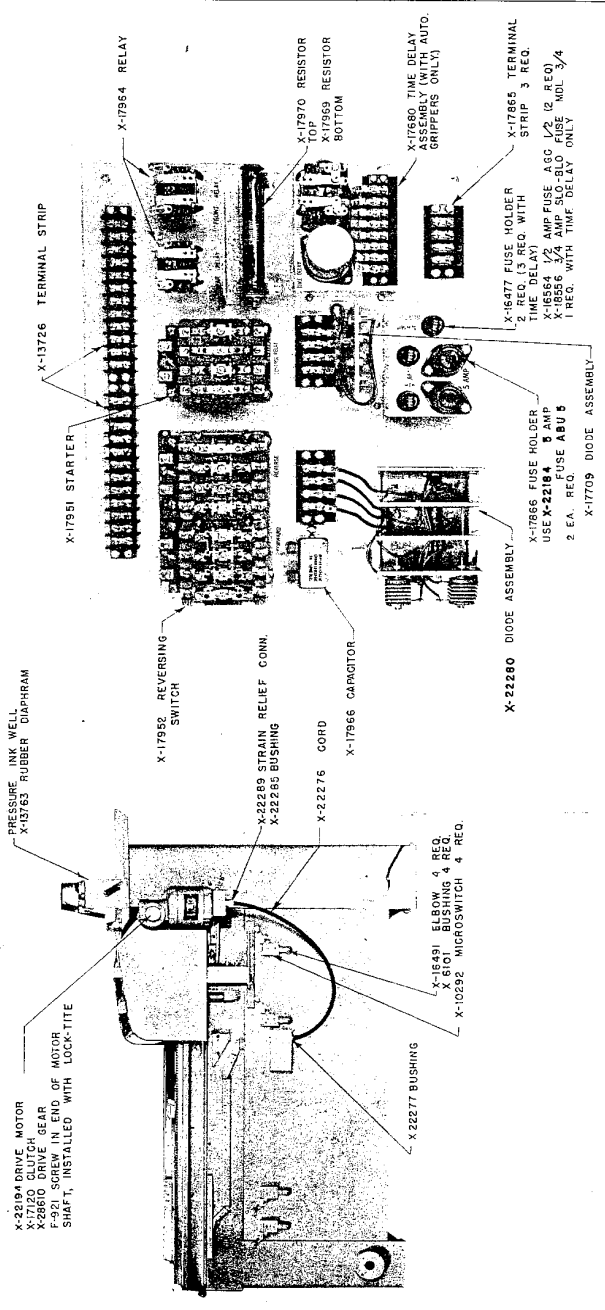

POWER DRIVE CONTROL STATIONS

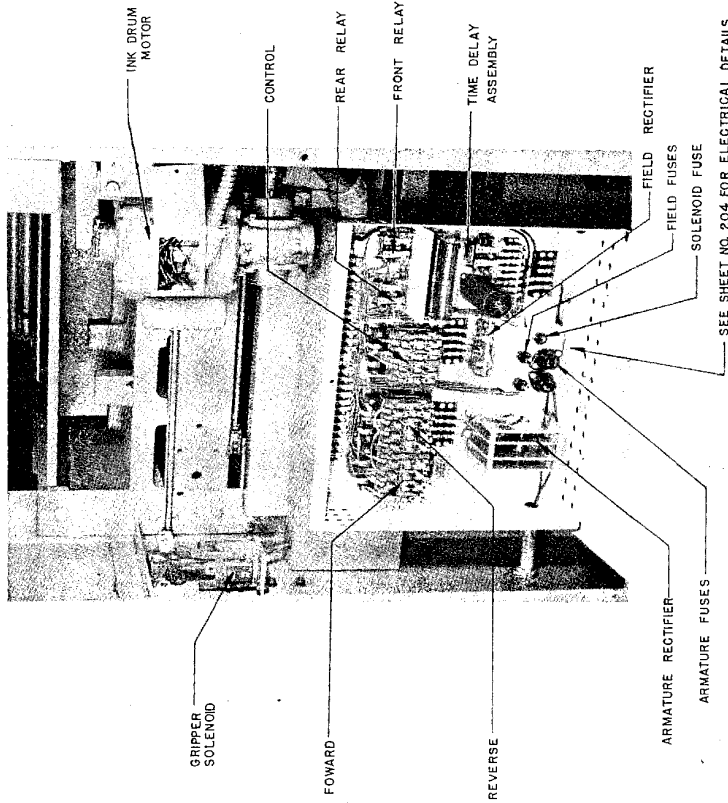
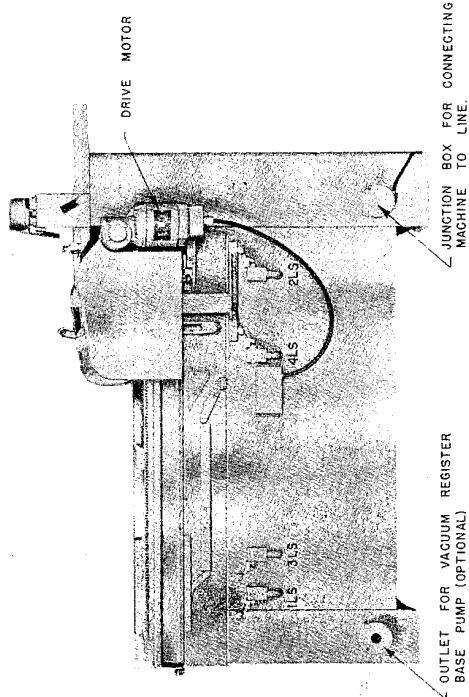
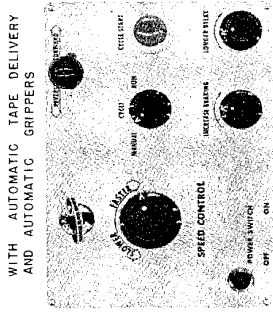
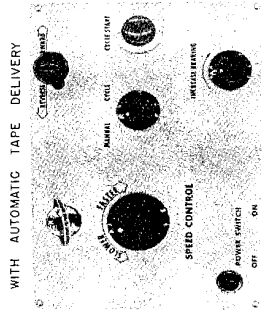
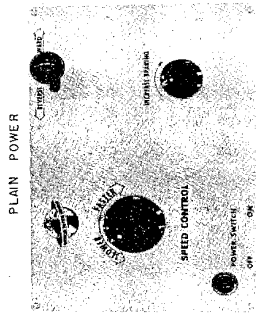

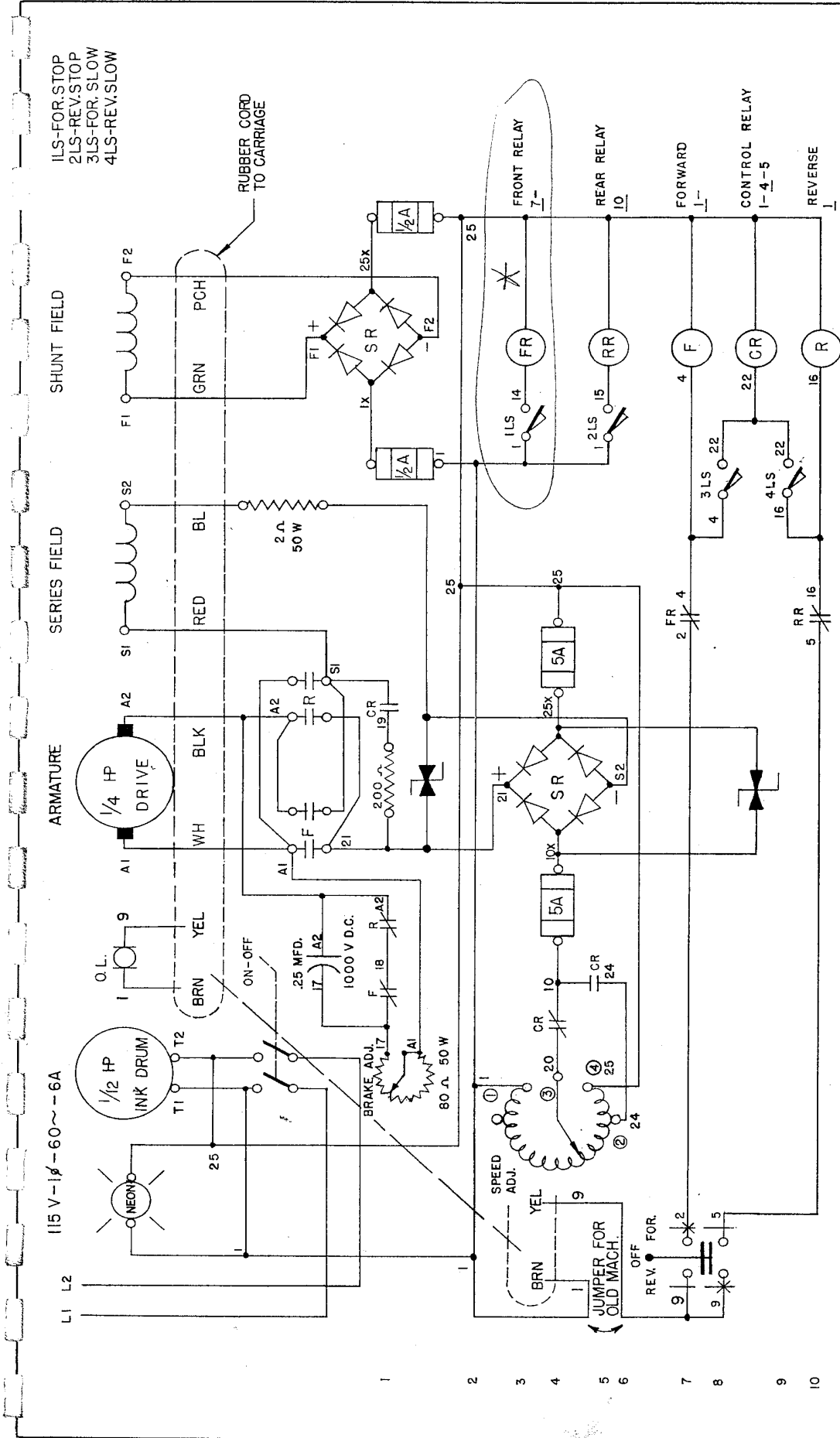

1LS-FOR, STOP  
 2LS-REV, STOP  
 3LS-FOR, SLOW  
 4LS-REV, SLOW

RUBBER CORD  
 TO CARRIAGE

SHUNT FIELD

SERIES FIELD

ARMATURE

115 V - 1ϕ - 60 ~ - 6A

SHEET NO. 217A

PLAIN POWER

UNIVERSAL III

L.U. NO. 25  
 NOT USED 3-6-7-8- -11-12-13-23  
 F.U. 22025

5C 2-66

115 V-1ϕ-60~-6A  
L1 L2

ARMATURE  
1/2 HP INK DRUM  
1/4 HP DRIVE

SERIES FIELD  
RED BLK

SHUNT FIELD  
GRN PCH

ILS-FOR.STOP  
2LS-REV.STOP  
3LS-FOR.SLOW  
4LS-REV.SLOW

RUBBER CORD FOR CARRIAGE

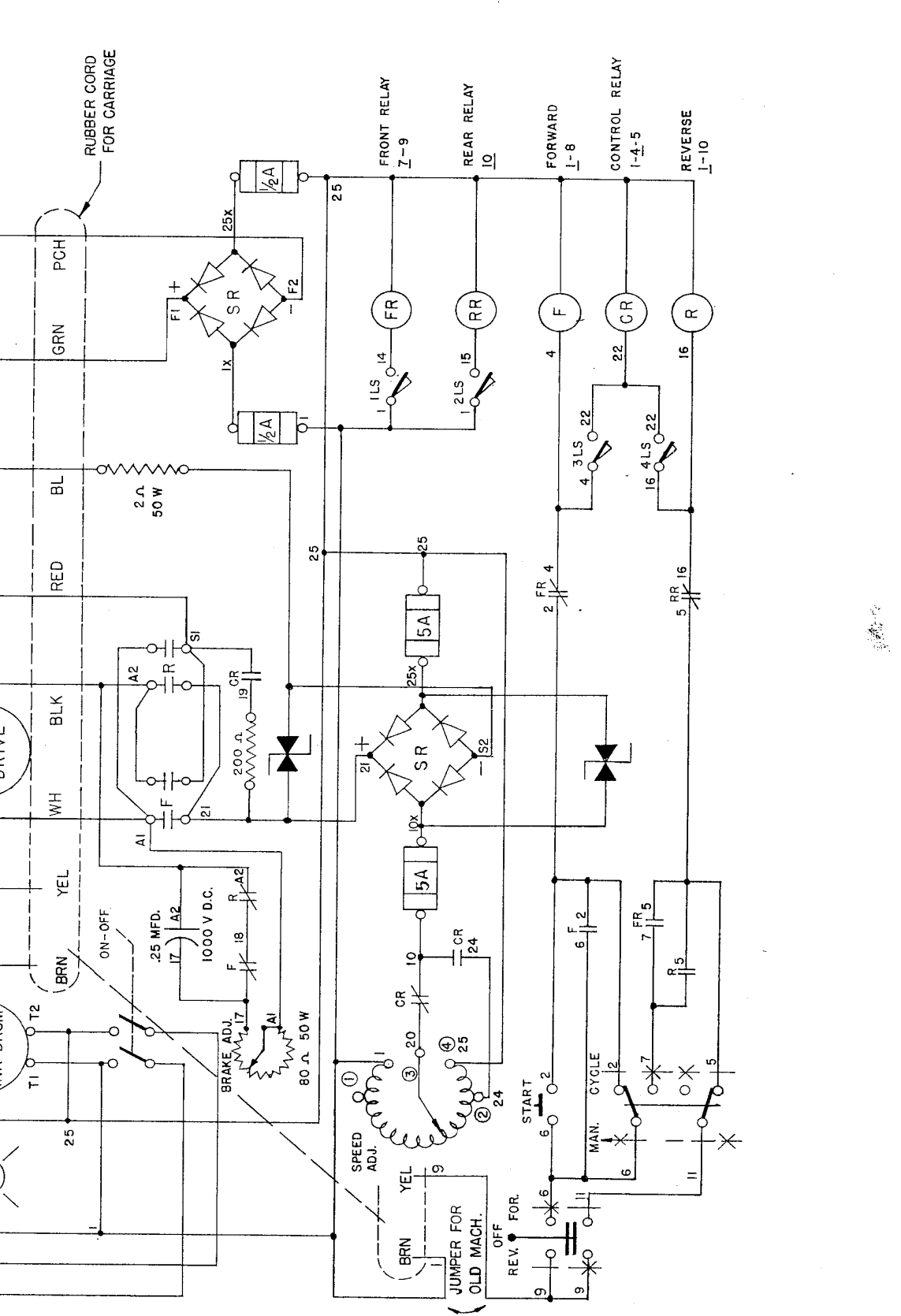

1LS-FOR, STOP  
 2LS-REV, STOP  
 3LS-FOR, SLOW  
 4LS-REV, SLOW

RUBBER CORD  
 TO CARRIAGE

SHUNT FIELD

SERIES FIELD

ARMATURE

115V-1ϕ-60~6A

1/2 HP  
 INK DRUM

1/4 HP  
 DRIVE

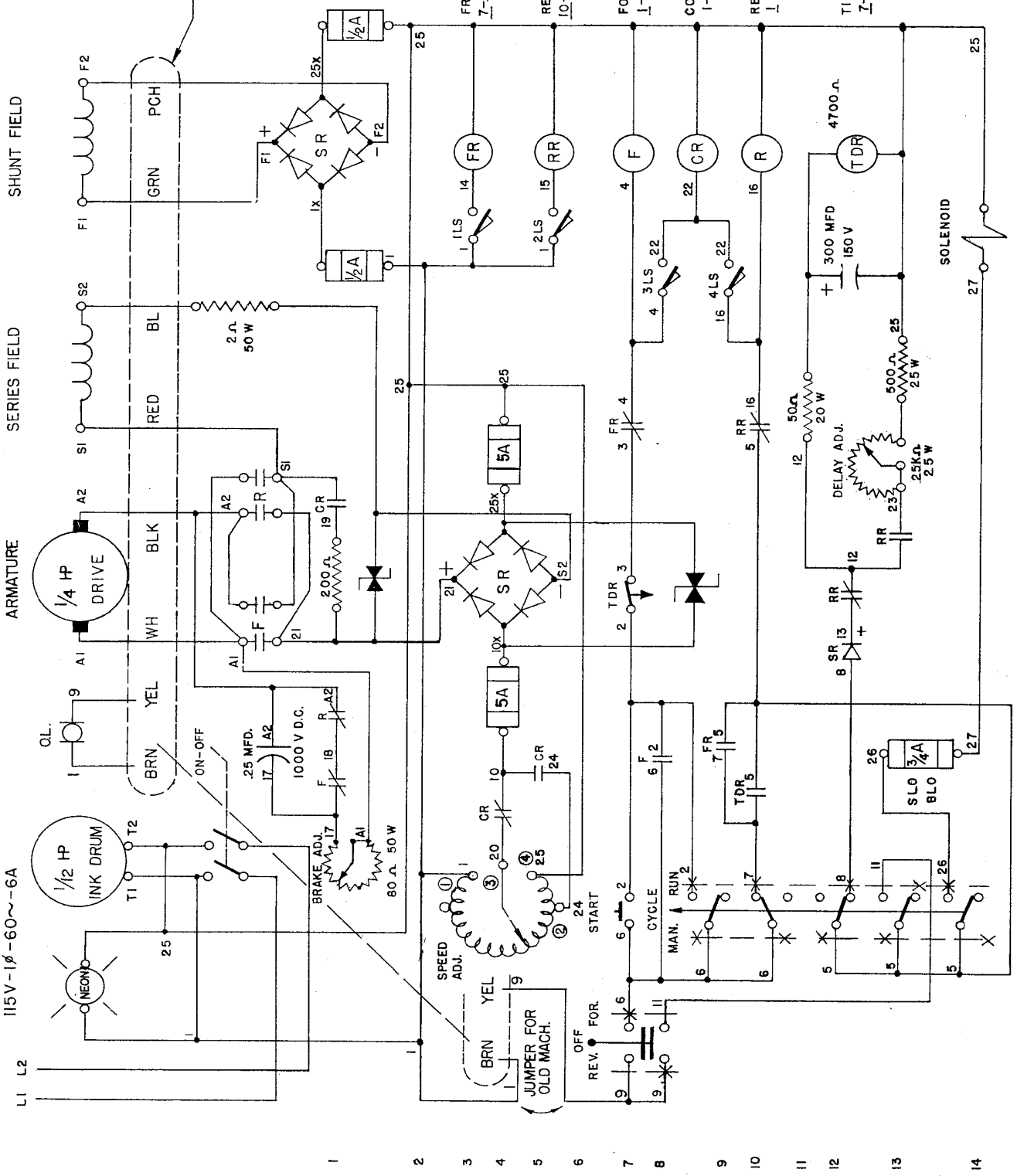

L.U. NO. 27  
 NOT USED  
 F.U. 22025

UNIVERSAL III

POWER DRIVE WITH AUTOMATIC  
 TAPE DELIVERY & AUTOMATIC  
 GRIPPER OPENER.

SHEET NO. 219 A